

Smith Performance Sprayers Backpack Sprayer

User Manual



David Golf & Engineering Pty Ltd

A.C.N 055 981 489 | A.B.N 85 260 948 796

Email: dge@davidgolf.com.au

Head Office Melbourne

PO Box 330

OAKLEIGH VIC 3166

Ph: 03 9542 0222

Fax: 03 9540 0909

SAFETY PRECAUTIONS

TEST SPRAYER WITH WATER BEFORE USING ANY CHEMICALS.

- Read owner's manual completely before operating this sprayer.
- Always use goggles, gloves, and protective clothing when using sprayer.
- Read and follow all instructions and cautions on label of products used in this sprayer.
- Never use flammable liquids, caustics, acids, or hot water in this tank.
- Do not leave sprayer in the sun when not in use.
- Spray when air is calm to prevent drift of chemicals.
- Do not use sprayer near open flame or anything that could cause ignition of the spray.
- Always inspect hose and all hose connections before each use. A damaged hose, or loose hose connection can result in unintended exposure to the pressurized chemical, resulting in serious injury or property damage.
- Do not lift or carry sprayer by the hose, shut-off valve, or wand extension. Carry by the handle only.
- Do not pressurize with any mechanical device such as an air compressor, since this can create a dangerous pressure level and bursting of parts resulting in serious injury. Only use original pump.
- Do not store chemicals in this tank.
- Always release pressure when sprayer is not in use and before performing any maintenance.

WARNING

ALWAYS CLEAN THE SPRAYER AND SHUT-OFF THOROUGHLY AFTER EACH USE OR WHEN CHANGING APPLICATIONS AS DESCRIBED IN THE CLEANING SECTION. FAILURE TO COMPLETELY CLEAN MAY CAUSE CROSS-CONTAMINATION.

WARNING

The sprayer is operated with liquid under pressure. Failure to observe caution and to follow instructions for operating and cleaning can cause tank, hose and other parts to be weakened and rupture under pressure. This can result in serious injury from high pressure discharge of liquids or forcible ejection of parts. Do not use flammable materials in this sprayer. Material could ignite or explode, causing serious injury and/or possible death. For safe use of this product, you must read and follow all instructions before use.

CAUTION

Always empty, clean and dry tank, pump system, shut-off, hose, and extension after each use. FAILURE TO DO SO MAY WEAKEN SPRAYER COMPONENTS, CAUSING COMPONENTS TO RUPTURE WHEN PRESSURIZED. Additionally, FAILURE TO CLEAN AND PROPERLY MAINTAIN YOUR SPRAYER WILL VOID MANUFACTURER'S WARRANTY.

Do not return sprayer to store, if you experience problems or have questions contact our toll free Customer Service Center, M-F 8AM - 5PM, EST, at 1-800-311-9903, or e-mail: Info@TheFGI.com, or access online at: www.TheFountainheadGroup.com.

ASSEMBLY INSTRUCTIONS

Assemble Extension, Shut-Off, Nozzle and Spray Optimizer

1. Install the extension "wand" onto the shut-off assembly and tighten the nut securely. (See Figure A)
2. (Optional) Install Spray Optimizer for low pressure (low drift) applications. This will help prevent weed killer formulas from drifting into undesired areas. (Do not over tighten, actual position will vary. See Figure B)
3. Install selected nozzle onto the end of the extension or optimizer (if installed) and tighten securely. (See Figure C)

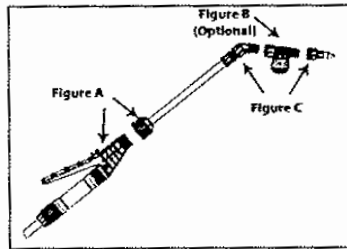

SELECT USING NOZZLE CHART BELOW (Nozzle selections vary by model)

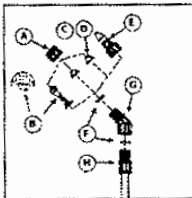

- A. Cap Nut
- B. Foaming Nozzle/High-Volume Foaming Nozzle
- C. Red High-Volume Fan Nozzle
- D. Yellow Low-Volume Fan Nozzle
- E. Adjustable Cone Nozzle
- F. Flat Seal
- G. Adapter

ADJUSTABLE CONE USES:	FOAMING NOZZLE USES:
<ul style="list-style-type: none"> Sport spraying in or around flower beds, trees, and shrubs. Edging along fences, driveways, and walkways. Killing brush such as poison ivy, poison oak, kudzu and wild blackberry. Preparing garden beds for planting of ornamentals and vegetables. 	<ul style="list-style-type: none"> Spot spraying in flower beds, walkways, driveways, and patios, around trees and shrubs. Edging along fences, driveways and walkways. Killing brush such as poison ivy, poison oak, kudzu and wild blackberry.
<ul style="list-style-type: none"> Lean replacement. Kill lawn and weeds before planting a new lawn. Preparing large areas for planting of ornamental and vegetable gardens. 	<ul style="list-style-type: none"> For precision spraying in confined areas such as gardens and flower beds.
<ul style="list-style-type: none"> For use where versatility is key. Helpful for spraying in Pest Control applications in patterns of tree fan, coarse fan, on, crack & crevice. 	<ul style="list-style-type: none"> For spraying chemicals where any liquid drop is not permitted. Perfect for areas that are sprayed where sensitive nearby.

Assemble Pump Handle

Slide handle onto shaft and line up holes. Thread bolt through handle and shaft and securely tighten. Thread on lock nut and tighten using a 13mm (or adjustable) wrench. Handle can be mounted on left or right depending on user preference. (See Figure D)

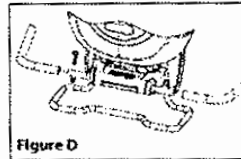

Folding Handle

1. Thread bolt through handle and shaft as stated above.



2. Snap strap around handle.

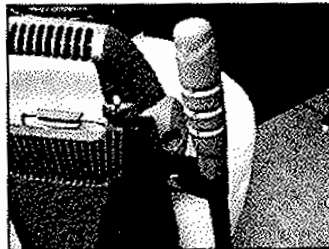

3. Handle shown in folded position.



OPERATING INSTRUCTIONS

Always conduct a test using cool, clean water before mixing chemicals.

Filling

Always refer to chemical manufacturer for proper mixture.

1. Remove the cap from the tank.
2. Make sure the filter basket is in place in the neck of the tank. The filter basket includes the seal and must be in place to prevent leaks.
3. Fill the tank with cool water and chemical to the desired level.
4. Reinstall the cap.

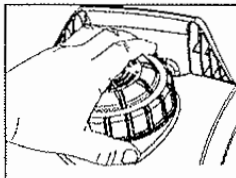

Pressurizing and Spraying

1. To begin pressurizing, be sure shut-off lever is not depressed. Pump handle up and down in a smooth motion (See Figure E). Operating pressure is reached when pumping becomes difficult, which is no more than 5-7 full pumps. (**Do not over-pressurize**)
2. Direct nozzle away from you and squeeze shut-off lever to begin spraying.
3. To maintain pressure while spraying, operate pump handle every 8 sec. or as needed to maintain desired pressure.
4. For continuous spraying, squeeze lever and rotate lock. (See Figure F)
5. Unlock if needed and release shut-off lever to stop spraying.

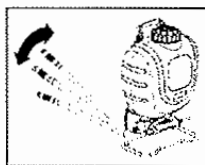

Figure E

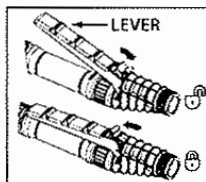

Figure F

Cleaning

1. Fill the tank with cool, clean tap water. Replace the cap and tighten securely. (**Never use hot water for cleaning**)
2. Agitate the tank to rinse the chemical from the tank walls.
3. Remove the cap and empty the contents into gravel or bare soil.
4. Refill the tank with clean tap water. Replace the cap and tighten securely.
5. Pressurize the tank as described in the *Pressurizing and Spraying* section.
6. Direct the nozzle away from you and activate the shut-off for at least 30 seconds to clean the pressure chamber, hose and shut-off.
7. Remove the cap and empty the contents into gravel or bare soil.
8. Repeat steps 4 - 7 until thoroughly cleaned. Remove nozzle when flushing pump system. Clean nozzle before replacing.

Sprayer Storage

1. Never store sprayer with pressure in chamber or liquid in any part of sprayer.
2. Sprayer tank should be hung upside down, with the cap removed, to dry completely.
3. Do not store or leave any solution in the tank after use.
4. Store in a warm, dry location out of direct sunlight.
5. **Keep the sprayer and all chemicals out of the reach of children.**

MAINTENANCE

Tank Maintenance

1. After each use, rinse the tank with cool, clean water.
2. Check the check valve (See **Figure G**) and filter basket gasket. (See **Figure H**)
Make sure they do not show signs of wear and are operating properly.
Replace them as required.
3. Clean any dirt or debris from the filter basket.
4. Periodically check the straps for fraying.
Replace them as required.



Figure G

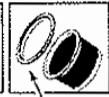
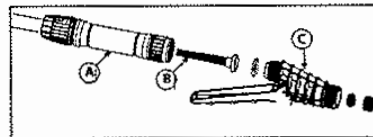

Figure H

Shut-off Maintenance (Smith Performance)

Always depressurize sprayer before maintenance by activating shut-off and spraying contents out.

1. Unscrew the handle from the shut-off assembly.
2. Remove the filter from the shut-off assembly.
3. Clean any debris from inside the handle, shut-off assembly, or the filter by rinsing with cool, clean water.
4. Reassemble the components as shown and tighten all connections securely.



A. Handle
B. Filter
C. Shut-off Assembly

Nozzle Maintenance

1. If nozzle clogs, remove and disassemble the nozzle assembly.
2. Clean the openings of any obstructions and reassemble.

Pressure Chamber Maintenance

WARNING: Always depressurize sprayer before cleaning or replacing pressure chamber by activating shut-off and spraying out all pressure.

1. Remove the tank cap and strainer (See **Figure I**).
2. Reach into the tank and turn the chamber 1/4 turn counterclockwise (See **Figure J**) to unlock the chamber from the pump then remove chamber from tank (See **Figure K**).
3. Rinse out any debris that may have accumulated in the chamber.
4. Reinstall the chamber into the pump by aligning the tabs on the chamber with the slots in the pump, push firmly into pump and turn clockwise until pump stops.
5. Reinstall the strainer and tank cap (See **Figure L**).

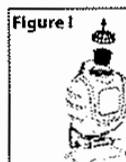

Figure I

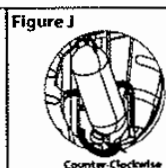

Figure J

Counterclockwise

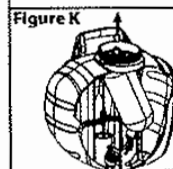

Figure K



Figure L

Clockwise

SERVICING INSTRUCTIONS

Prior to servicing and/or repairs.

1. Empty contents of tank.
2. While squeezing shut-off, pump sprayer until all liquid is expelled.
3. Continue squeezing shut-off without pumping to release all air pressure.
4. You will find all parts for servicing primary seals and gaskets to be included in **KIT #32**.

Tank Servicing Steps

1. Unscrew cap from tank. Remove and replace check valve. (See Figure 1)
2. Remove pressure chamber as outlined in *Pressure Chamber Maintenance* section of the manual. Remove and replace o-ring. Lubricate o-ring with petroleum jelly. (See Figure 2)
3. Unsnap agitator from piston rod. Remove from tank. (See Figure 3)



Figure 1



Figure 2

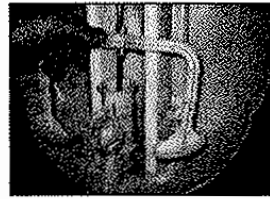

Figure 3

4. Position pump handle to the furthest downward position. Remove pump handle from sprayer. (See Figure 4)
5. Disassemble carry handle by removing the (6) screws. (See Figure 5)
6. Remove hitch pin and lift pivot clip off of the piston rod. (See Figure 6)



Figure 4

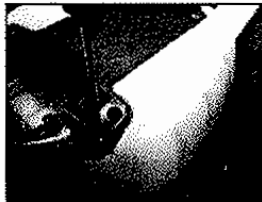

Figure 5



Figure 6

SERVICING INSTRUCTIONS CONTINUED

7. Pull upward to slide piston rod out of pump. (See Figure 7)
8. While holding onto the pump, use an adjustable wrench to unthread pump nut from pump. Remove nut, hose and barb assembly. (See Figure 8)
9. Inspect (2) o-rings on barb assembly. If damaged, replace hose assembly. (See Figure 9)

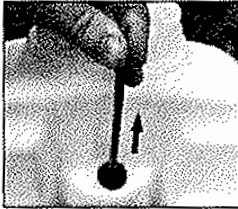

Figure 7

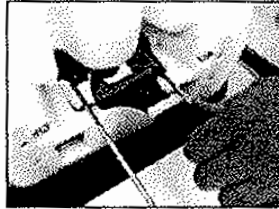

Figure 8



Figure 9

10. Remove pump out of tank. Remove and replace gasket. (See Figure 10)
11. Slide piston rod assembly down and out of grommet and remove from tank. (See Figure 11)
12. Carefully remove and replace o-ring from piston. Lubricate o-ring with petroleum jelly. (See Figure 12)



Figure 10

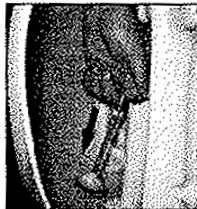

Figure 11

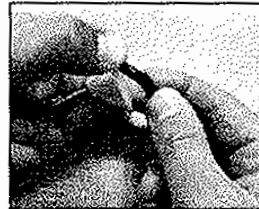
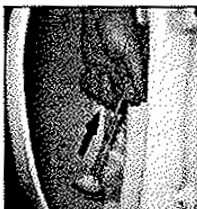

Figure 12

13. Remove grommet from tank using pliers to grasp the head of the grommet while flexing the grommet out of the hole in the tank. Press or tap new grommet into tank. Lubricate hole in grommet with petroleum jelly. (See Figure 13)
14. Insert piston rod assembly into tank and through grommet. (See Figure 14)
15. Reassemble pump with gasket into tank. (See Figure 15) for correct orientation. Tighten pump nut securely with adjustable wrench while holding pump to maintain correct orientation. Push piston assembly into pump.



SERVICING INSTRUCTIONS CONTINUED

16. Attach pivot clip to piston rod and insert hitch pin. Note orientation of piston rod must match the pivot clip. (See Figure 16)
17. Reassemble carry handle onto tank. Tighten all (6) screws. (See Figure 5)
18. To reinstall the agitator, line the notch up on the agitator with the swedge on piston rod and snap into place. (See Figure 17)
19. Reinstall pressure chamber as outlined in the *Pressure Chamber Maintenance* section. (See Figure 18)

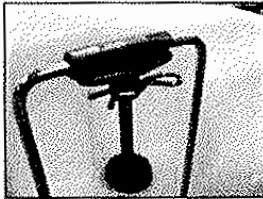

Figure 16



Figure 17



Figure 18

20. Replace tank cap, filter (See Figure 19) and pump handle (See Figure 4).



Figure 19

Harness Installation

1. For each side, remove the small plastic clips from the two shoulder strap loops and thread each loop through the slots at the top of the carry handle. Replace the clips through the loops and pull strap securing the two shoulder straps in place. (See Figure 20)
2. To install lower end of the straps, remove strap from top portion of buckles and place around the foot stand, starting from underneath. (See Figure 21)
3. Loop strap through the first section of buckle. (See Figure 22)
4. Next loop strap through other section of buckle and tighten (See Figure 23). Adjust the shoulder pads and strap length for a comfortable fit.



Figure 20



Figure 21



Figure 22

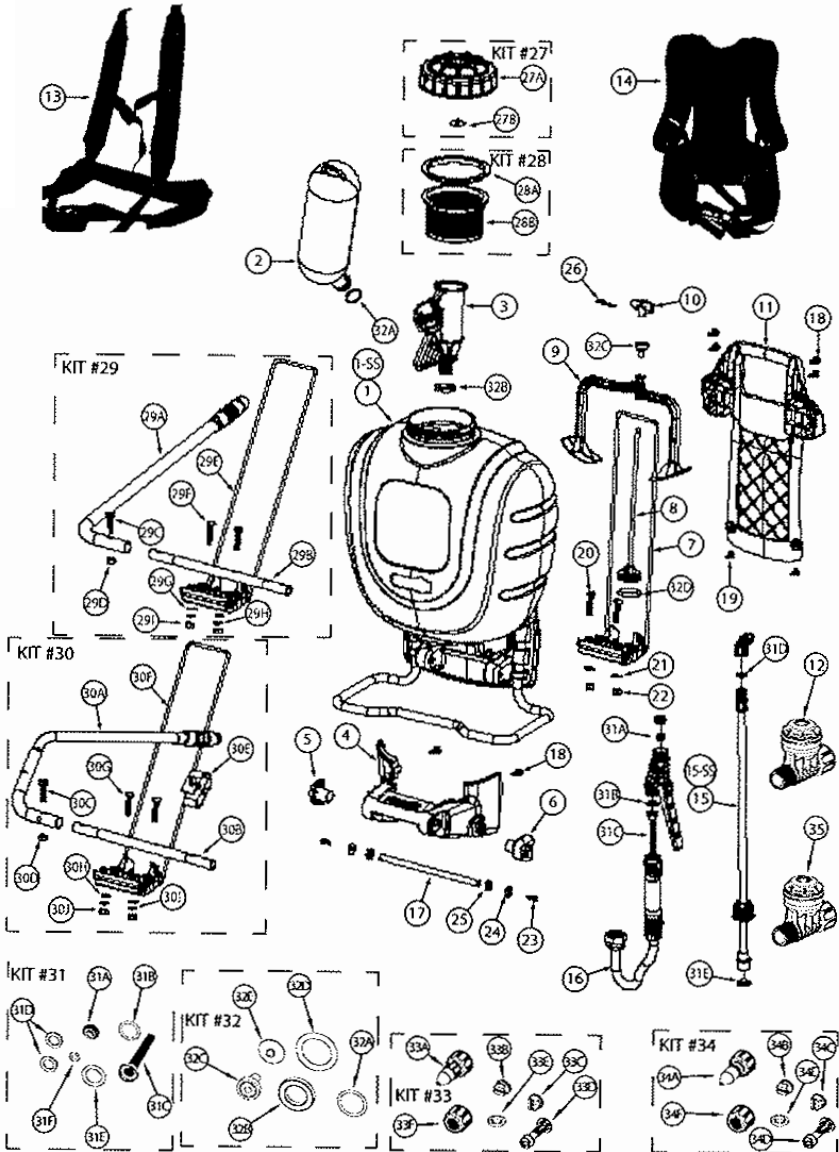

Figure 23

TROUBLESHOOTING

TROUBLE	LOOK FOR	REMEDY
Sprayer starts to spray when pumping or sprayer will not stop spraying when shut-off lever is released.	Shut-off lock is engaged.	Squeeze shut-off lever and disengage the lock. See <i>Pressurizing and Spraying</i> section.
Sprayer will not build pressure.	<ol style="list-style-type: none"> 1. Pressure chamber (#2) installed into pump (#3). 2. Dirty, damaged or worn pump or chamber o-ring (#32A). 3. Dirty poppet in pump. 	<ol style="list-style-type: none"> 1. Install pressure chamber as described in <i>Pressure Chamber Maintenance</i> section. 2. Clean and lubricate or replace o-rings as described in <i>Servicing</i> section. 3. Clean sprayer as described in <i>Cleaning</i> section.
Sprayer will not spray.	<ol style="list-style-type: none"> 1. Sprayer pressurization. 2. Shut-off clogged. 3. Nozzle clogged. 	<ol style="list-style-type: none"> 1. Pressurize sprayer as described in <i>Pressurizing and Spraying</i> section. 2. Clean shut-off as described in <i>Shut-off Maintenance</i> section. 3. Clean nozzle as described in <i>Nozzle Maintenance</i> section.
Sprayer leaks from the bottom of the tank.	<ol style="list-style-type: none"> 1. Loose pump nut (#16). 2. Damaged or worn o-rings or seals (kit #32). 	<ol style="list-style-type: none"> 1. Tighten pump nut as described in <i>Servicing</i> section. 2. Replace o-rings and seals as described in <i>Servicing</i> section.
Sprayer leaks where piston rod enters top of the tank.	Dirty, damaged, or worn grommet (#32C).	Clean and lubricate hole in grommet or replace grommet as described in <i>Servicing</i> section.
Hose leaks at tank connection.	Cracked, swollen or faulty hose.	Replace shut-off assembly.
Hose leaks at shut-off.	Cracked, swollen or faulty hose.	Replace shut-off assembly.
Pump handle is difficult to operate.	<ol style="list-style-type: none"> 1. Swollen or damaged pump piston o-ring (#32D). 2. Dirty, dry or damaged grommet (#32C). 	<ol style="list-style-type: none"> 1. Clean and lubricate or replace o-ring as described in <i>Servicing</i> section. 2. Clean and lubricate hole in grommet or replace grommet as described in <i>Servicing</i> section.
Nozzle drips when shut-off lever is released.	<ol style="list-style-type: none"> 1. Dirt or debris in shut-off valve. 2. Damaged o-ring or seal in shut-off (kit #31). 	<ol style="list-style-type: none"> 1. Clean shut-off as described in <i>Shut-off Maintenance</i> section. 2. Service shut-off seals as described in <i>Maintenance service kit #31</i>.
Nozzle tip leaks, poor spray pattern, partial spray or complete stoppage.	<ol style="list-style-type: none"> 1. Flat seal is missing or damaged. 2. Spray extension or nozzle clogged. 	<ol style="list-style-type: none"> 1. Replace flat seal at extension tip (kit #31). 2. Remove nozzle and clean as described in <i>Nozzle Maintenance</i> section.

KITS, PARTS & ACCESSORIES



KEY#	PART#	DESCRIPTION
1	181700	TANK ASSEMBLY
1-SS	182104	TANK ASSEMBLY, STAINLESS STEEL
2	182008	HIGH CAPACITY RESERVOIR / CHAMBER ASSEMBLY
3	182070	PUMP
4	181635	DRIVE SUPPORT SHROUD
5	181653	LEFT BUSHING
6	181654	RIGHT BUSHING
7	181954	DRIVE LEVER ASSEMBLY
8	181669	PUMP PISTON ASSEMBLY
9	181665	STANDARD AGITATOR
10	181641	PIVOT CLIP
11	181648	BACK HANDLE
12	181826	PRESSURE REGULATOR (25 PSI)
13	181659	SHOULDER HARNESS (STANDARD)
14	181889	SHOULDER HARNESS (DELUXE)
15	181824	21" WAND ASSEMBLY
15-SS	182112	21" WAND ASSEMBLY, STAINLESS STEEL
16	181925	SHUT-OFF ASSEMBLY, SMITH PRO (BACKPACK VER.)
17	181649	SHROUD ROD
18	181529	SCREW, UPPER HANDLE (1) & SHROUD (2)
19	181716	SCREW, LOWER HANDLE (2)
20	182017	DRIVE LEVER BOLT (2)
21	181906	DRIVE LEVER FLAT WASHER (2)
22	181757	LOCK NUT (2)
23	181651	SHROUD SCREW (2)
24	181684	SHROUD WASHER (2)
25	181650	SHROUD SPACER (2)
26	181673	HITCH PIN

KIT #27 182400 CAP ASSEMBLY KIT (VITON)

27A	181444	TANK CAP
27B	171015V	CHECK VALVE(VITON)

KIT #28 181564 FILTER BASKET ASSEMBLY KIT

28A	181445	FILTER BASKET GASKET
28B	181519	FILTER BASKET

KIT #29 181788 BOLT-ON PUMP HANDLE KIT (STANDARD)

29A	181922	STANDARD PUMP HANDLE ASSEMBLY (GRIP INCLUDED)
29B	181753	BOLT-ON DRIVE SHAFT
29C	181756	HEX BOLT
29D	181757	LOCK NUT
29E	181954	DRIVE LEVER ASSEMBLY
29F	182021	DRIVE LEVER BOLT, 40mm (2)
29G	181906	DRIVE LEVER FLAT WASHER (2)
29H	181908	DRIVE LEVER LOCK WASHER (2)
29I	181907	DRIVE LEVER NUT (2)

KIT #30 182657 BOLT-ON PUMP HANDLE KIT (FOLDING)

30A	182107	STAINLESS FOLDING PUMP HANDLE ASSEMBLY (GRIP INCLUDED)
30B	182106	BOLT-ON DRIVE SHAFT, STAINLESS STEEL
30C	181756	HEX BOLT
30D	181757	LOCK NUT
30E	181772	RETAINER STRAP
30F	181954	DRIVE LEVER ASSEMBLY
30G	182021	DRIVE LEVER BOLT, 40mm (2)
30H	181906	DRIVE LEVER FLAT WASHER (2)
30I	181908	DRIVE LEVER LOCK WASHER (2)
30J	181907	DRIVE LEVER NUT (2)

KIT #31 181910 SMITH PRO SHUT-OFF SERVICE KIT

31A	181840	POPPET SEAL
31B	181493	VALVE BODY O-RING
31C	181468	FILTER
31D	181812	FLAT NOZZLE SEAL (2)
31E	181810	WAND O-RING
31F	181805	ADJUSTABLE NOZZLE O-RING

KIT #32 182656 BACKPACK SERVICE KIT

32A	171488V	RESERVOIR / CHAMBER O-RING
32B	171740	PUMP GASKET
32C	181668	TANK GROMMET
32D	171487V	PISTON O-RING
32E	171015V	CHECK VALVE, VITON

KIT #33 181869 POLY NOZZLE KIT

33A	181822	POLY ADJUSTABLE NOZZLE
33B	180168	YELLOW FLAT FAN NOZZLE (LOW VOLUME)
33C	180097	RED FLAT FAN NOZZLE (HIGH VOLUME)
33D	180266	FOAMING NOZZLE
33E	181812	FLAT NOZZLE SEAL
33F	181804	NOZZLE CAP NUT

KIT #34 181870 BRASS NOZZLE KIT

34A	181823	BRASS ADJUSTABLE NOZZLE
34B	180168	YELLOW FLAT FAN NOZZLE (LOW VOLUME)
34C	180097	RED FLAT FAN NOZZLE (HIGH VOLUME)
34D	180266	FOAMING NOZZLE
34E	181812	FLAT NOZZLE SEAL
34F	181804	NOZZLE CAP NUT

KIT #35 181825 14 PSI PRESSURE REGULATOR KIT

35	181825	14 PSI PRESSURE REGULATOR ASSEMBLY
----	--------	------------------------------------

KITS, PARTS & ACCESSORIES

"XL" Shut-Off and Wand

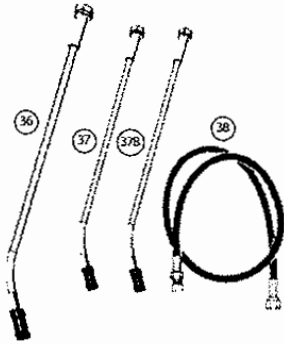

KIT #41 (18" WAND)
KIT #41A (24" WAND)

KIT #42

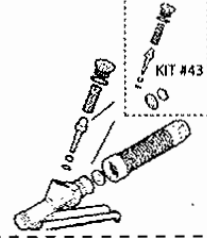

"XB" Shut-Off and Wand

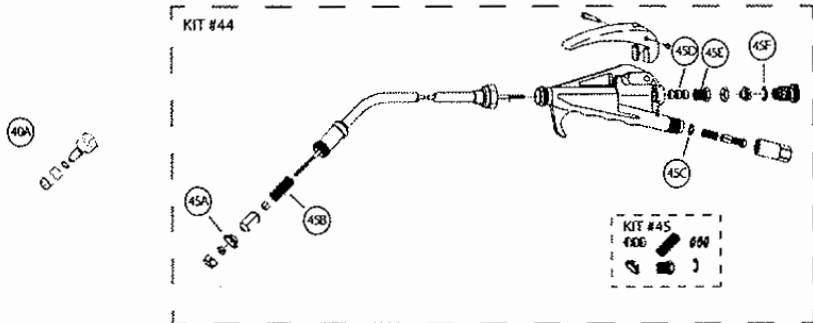

"ZL" Shut-Off and Wand

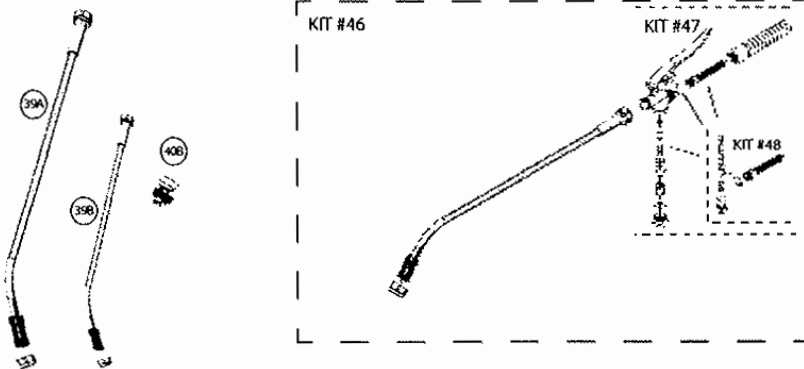

KEY#	PART#	DESCRIPTION
36	182661	24" BRASS WAND ASSEMBLY FOR XL SHUT-OFF
37	182659	18" BRASS WAND ASSEMBLY FOR XL SHUT-OFF, BACKPACK
37B	182660	18" BRASS WAND ASSEMBLY FOR XL SHUT-OFF, COMPRESSION AIR TANK
38	182571	50" HOSE ASSEMBLY FOR XL SHUT-OFF
39A	182662	18" SS WAND ASSEMBLY FOR ZL SHUT-OFF
39B	182639	12" SS WAND ASSEMBLY FOR ZL SHUT-OFF
40A	182567	BRASS ADJUSTABLE NOZZLE
40B	182379	4-WAY ADJUSTABLE NOZZLE

KIT #41 182634 XL SHUT-OFF & WAND ASSEMBLY

KIT #42	XL SHUT-OFF ASSEMBLY
37	18" BRASS WAND ASSEMBLY FOR XL SHUT-OFF

KIT #41A 182635 XL SHUT-OFF & WAND ASSEMBLY

KIT #42	XL SHUT-OFF ASSEMBLY
36	24" BRASS WAND ASSEMBLY FOR XL SHUT-OFF

KIT #42 182563 COMPLETE XL SHUT-OFF ASSEMBLY

KIT #43 182568 XL SHUT-OFF REPAIR KIT

43A	VALVE STEM SUB-ASSEMBLY
43B	BRASS GUIDE
43C	O-RING #1
43D	GASKET, COPPER
43E	VALVE SPRING
43F	VITON O-RING
43G	FLAT GASKET

KIT #44 182663 COMPLETE XB SHUT-OFF ASSEMBLY

KIT #45 182569 XB SHUT-OFF REPAIR KIT

45A	GASKET, SOFT SEAT
45B	SPRING, SEAT STEM
45C	GASKET, NYLON (3)
45D	PACKING, VALVE (3)
45E	NUT, PACKING
45F	RING, SNAP

KIT #46 182636 COMPLETE ZL SHUT-OFF & WAND ASSEMBLY

KIT #47	ZL SHUT-OFF ASSEMBLY
39A	18" STAINLESS STEEL WAND FOR ZL SHUT-OFF

KIT #47 182465 COMPLETE ZL SHUT-OFF ASSEMBLY

KIT #48 182621 ZL SHUT-OFF REPAIR KIT

48A	ORING, SS SHUT-OFF VALVE, V (QTY 2)
48B	CAP, SS SHUT-OFF VALVE BODY
48C	SPRING, SS SHUT-OFF VALVE
48D	BASE, SS SHUT-OFF VALVE
48E	STEM, SS SHUT-OFF VALVE
48F	SEAL, SS SHUT-OFF VALVE, V
48G	O-RING, SS SHUT-OFF VALVE, V
48H	FILTER, SS SHUT-OFF